

Metropolitan Area Planning Council

Bike Parking Program Pricelist 2017



SIMPLY DESIGNED TO LAST. GUARANTEED.*





In Partnership with:

Berkshire Regional Planning Commission
Cape Cod Commission
Central Massachusetts Regional Planning Commission
Franklin Regional Council of Governments
Martha's Vineyard Commission
Merrimack Valley Planning Commission
Montachusett Regional Planning Commission
Nantucket Planning and Economic Development Commission
Northern Middlesex Council of Governments
Old Colony Planning Council
Pioneer Valley Planning Commission
Southeastern Regional Planning and Economic Development District
Massachusetts Bay Transportation Authority (MBTA)
Department of Conservation and Recreation (DCR)

March 6, 2017



Item Image	Item Number	Product Description	Saris MSRP	"MAPC Bike Rack" Pricing	% Difference	10 +	25 +	50 +	100 +
Apex Shelter									
		9' x 10' shelter, 6 bike capacity	\$4,950.00	\$ 4,455.00	10%	\$ 4,455.00	\$ 4,455.00	\$ 4,455.00	\$ 4,455.00
		9' x 13' shelter, 8 bike capacity	\$6,435.00	\$ 5,791.00	10%	\$ 5,791.00	\$ 5,791.00	\$ 5,791.00	\$ 5,791.00
		9' x 16' shelter, 10 bike capacity	\$7,920.00	\$ 7,128.00	10%	\$ 7,128.00	\$ 7,128.00	\$ 7,128.00	\$ 7,128.00
Parachute Shelter									
		9' x 10' shelter, 6 bike capacity	\$10,098.00	\$ 9,088.00	10%	\$ 9,088.00	\$ 9,088.00	\$ 9,088.00	\$ 9,088.00
		9' x 13' shelter, 8 bike capacity	\$11,178.00	\$ 10,060.00	10%	\$ 10,060.00	\$ 10,060.00	\$ 10,060.00	\$ 10,060.00
		9' x 16' shelter, 10 bike capacity	\$12,258.00	\$ 11,032.00	10%	\$ 11,032.00	\$ 11,032.00	\$ 11,032.00	\$ 11,032.00
Anchor Kits									
	6257	ANCHOR - CEMENT KIT (QTY 1)	\$20.00	\$ 11.89	41%	\$ 11.77	\$ 11.65	\$ 11.54	\$ 11.42
	6258	ANCHOR - EARTH (QTY 1)	\$20.00	\$ 11.89	41%	\$ 11.77	\$ 11.65	\$ 11.54	\$ 11.42
	6259	ANCHOR - 6" CEMENT SPIKE (QTY 4)	\$20.00	\$ 11.89	41%	\$ 11.77	\$ 11.65	\$ 11.54	\$ 11.42
	6260	ANCHOR - 3" CEMENT SPIKE (QTY 8)	\$20.00	\$ 11.89	41%	\$ 11.77	\$ 11.65	\$ 11.54	\$ 11.42
	6263	ANCHOR - LAG BOLTS & SHIELDS (QTY 8)	\$20.00	\$ 11.89	41%	\$ 11.77	\$ 11.65	\$ 11.54	\$ 11.42
	6264	ANCHOR - LAG BOLTS & SHIELDS (QTY 4)	\$12.00	\$ 7.36	39%	\$ 7.29	\$ 7.21	\$ 7.14	\$ 7.07
	6265	ANCHOR - 3" CEMENT SPIKE (QTY 4)	\$12.00	\$ 7.36	39%	\$ 7.29	\$ 7.21	\$ 7.14	\$ 7.07
	6266	ANCHOR - 4" CEMENT SPIKE (QTY 4)	\$20.00	\$ 11.89	41%	\$ 11.77	\$ 11.65	\$ 11.54	\$ 11.42
	6267	ANCHOR - 6" ASPHALT SPIKE (QTY 4)	\$54.00	\$ 54.00	0%	\$ 53.46	\$ 52.93	\$ 52.40	\$ 51.87

Standard Coating is TGIC Polyester Powdercoat

All racks available in the following standard colors:

Multiple corrosive resistant coatings available for an additional charge



Call Emelye Sturges @ 608-274-6154 for price quote

2017 MAPC Price List

Single Racks

Arc Rack

Surface Mount (FT)

Inground Mount [Parks 2 Bikes]	
Powder Coat or Galvanized.....	\$201.00
Thermoplastic.....	\$235.00
Surface Mount [Parks 2 Bikes]	
Powder Coat or Galvanized.....	\$240.00
Thermoplastic.....	\$275.00

Please contact Dero for stainless steel pricing.
Thermoplastic finish includes galvanized base finish.

Bike Bike Rack

Surface or Inground Mount [Parks 2-4 Bikes]	
Powder Coat or Galvanized.....	\$397.00
Thermoplastic.....	\$443.00

Please contact Dero for stainless steel pricing.
Thermoplastic finish includes galvanized base finish.

Bike Hitch

Inground Mount [Parks 2 Bikes]	
Powder Coat or Galvanized.....	\$106.00
Thermoplastic or Black Rubber Dip.....	\$144.00
Surface Mount [Parks 2 Bikes]	
Powder Coat or Galvanized.....	\$111.00
Thermoplastic or Black Rubber Dip.....	\$150.00

Please contact Dero for stainless steel pricing.
Thermoplastic and black rubber dip finishes include galvanized base finish.

Meter Hitch

pat. D620,8455



Capped option available for poles with meters removed.

Pole Mount [Parks 2 Bikes]	
Powder Coat or Galvanized.....	\$143.00
Thermoplastic.....	\$184.00

Pricing applies to capped and uncapped options
Please contact Dero for stainless steel pricing.
Thermoplastic finish includes galvanized base finish.

2017 MAPC Price List

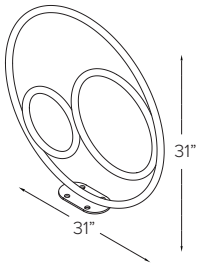
Recycle Rack Circles

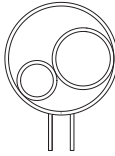





Surface Mount Inground Mount

Inground or Surface Mount [Parks 2 Bikes]
 Powder Coat or Galvanized..... \$275.00
 Thermoplastic..... \$303.00

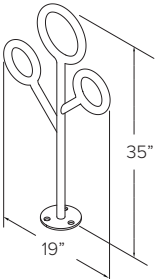
Please contact Dero for stainless steel pricing.
 Thermoplastic finish includes galvanized base finish.

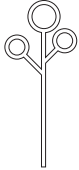
Recycle Rack Tree







Surface Mount Inground Mount

Inground or Surface Mount [Parks 2 Bikes]
 Powder Coat or Galvanized..... \$269.00
 Thermoplastic..... \$299.00

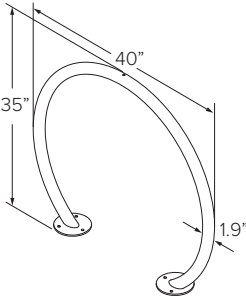
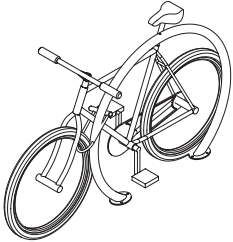
Please contact Dero for stainless steel pricing.
 Thermoplastic finish includes galvanized base finish.

Round Rack

Surface Mount (FT)

Inground Mount [Parks 2 Bikes]
 Powder Coat or Galvanized..... \$183.00
 Thermoplastic..... \$224.00

Surface Mount [Parks 2 Bikes]
 Powder Coat or Galvanized..... \$196.00
 Thermoplastic..... \$236.00

Please contact Dero for stainless steel pricing.
 Thermoplastic finish includes galvanized base finish.

Multiple Racks

Campus Rack

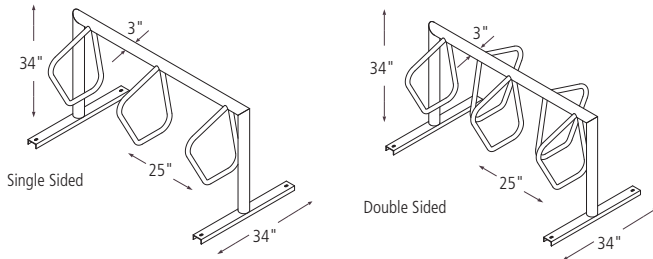

Please contact Dero for stainless steel pricing.
Thermoplastic finish includes galvanized base finish.

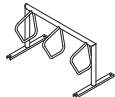
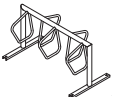
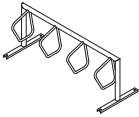
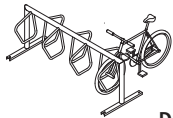
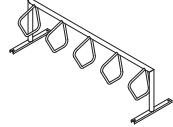
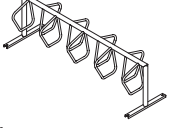
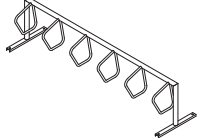
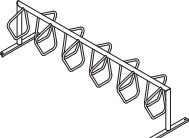
 <p>S3 Campus Rack [Parks 3-5 Bikes] [63.25" Long] Inground or Surface Mount Powder Coat or Galvanized..... \$371.00 Thermoplastic..... \$428.00</p>	 <p>D5 Campus Rack [Parks 5-7 Bikes] [63.25" Long] Inground or Surface Mount Powder Coat or Galvanized..... \$419.00 Thermoplastic..... \$513.00</p>
 <p>S4 Campus Rack [Parks 4-6 Bikes] [88.25" Long] Inground or Surface Mount Powder Coat or Galvanized..... \$404.00 Thermoplastic..... \$470.00</p>	 <p>D7 Campus Rack [Parks 7-9 Bikes] [88.25" Long] Inground or Surface Mount Powder Coat or Galvanized..... \$568.00 Thermoplastic..... \$672.00</p>
 <p>S5 Campus Rack [Parks 5-7 Bikes] [113.25" Long] Inground Mount or Surface Mount Powder Coat or Galvanized..... \$513.00 Thermoplastic..... \$591.00</p>	 <p>D9 Campus Rack [Parks 9-11 Bikes] [113.25" Long] Inground Mount or Surface Mount Powder Coat or Galvanized..... \$623.00 Thermoplastic..... \$733.00</p>
 <p>S6 Campus Rack [Parks 6-8 Bikes] [138.25" Long] Inground Mount or Surface Mount Powder Coat or Galvanized..... \$591.00 Thermoplastic..... \$679.00</p>	 <p>D11 Campus Rack [Parks 11-13 Bikes] [138.25" Long] Inground Mount or Surface Mount Powder Coat or Galvanized..... \$699.00 Thermoplastic..... \$814.00</p>

Downtown Rack

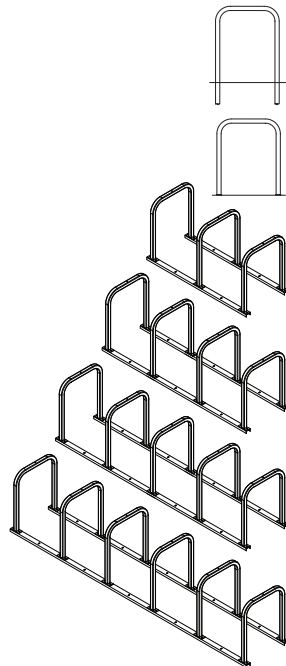
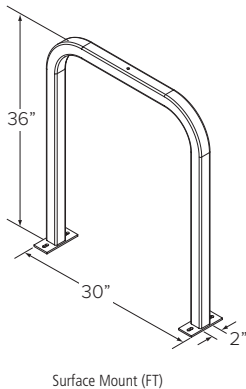

<p>Inground Mount [Parks 2 Bikes] Powder Coat or Galvanized..... \$100.00 Thermoplastic or Black Rubber Dip..... \$139.00</p>
<p>Surface Mount [Parks 2 Bikes] Powder Coat or Galvanized..... \$117.00 Thermoplastic or Black Rubber Dip..... \$157.00</p>
<p>3 Downtown Rail Mount [Parks 6 Bikes] [76"] Powder Coat or Galvanized..... \$469.00 Thermoplastic or Black Rubber Dip..... \$589.00</p>
<p>4 Downtown Rail Mount [Parks 8 Bikes] [111"] Powder Coat or Galvanized..... \$638.00 Thermoplastic or Black Rubber Dip..... \$797.00</p>
<p>5 Downtown Rail Mount [Parks 10 Bikes] [146"] Powder Coat or Galvanized..... \$825.00 Thermoplastic or Black Rubber Dip..... \$1,025.00</p>
<p>6 Downtown Rail Mount [Parks 12 Bikes] [181"] Powder Coat or Galvanized..... \$1,027.00 Thermoplastic or Black Rubber Dip..... \$1,267.00</p>

Please contact Dero for stainless steel pricing.
Thermoplastic and rubber dip finishes include galvanized base finish.
All rails are galvanized.

2017 MAPC Price List

Helix

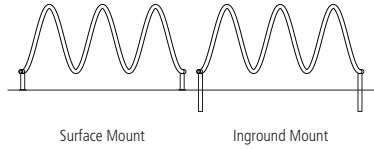
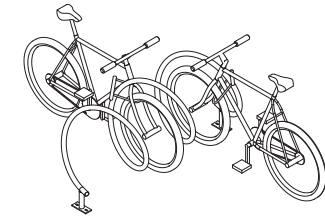
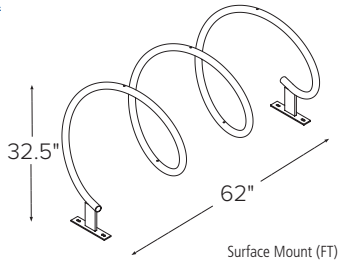

Inground or Surface Mount [Parks 6 Bikes]

Powder Coat or Galvanized	\$327.00
Thermoplastic	\$381.00

Please contact Dero for stainless steel pricing.
Thermoplastic finish includes galvanized base finish.

Hi Roller

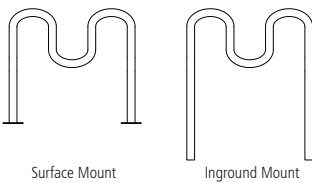
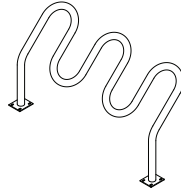
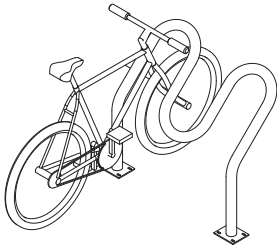
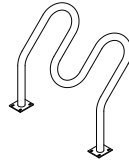
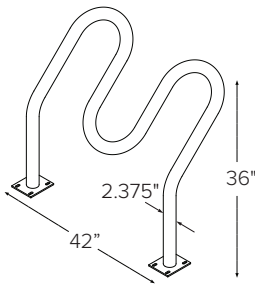

Hi Roller 2H [Parks 4 Bikes] [41" Long]

Inground Mount

Powder Coat or Galvanized	\$276.00
Thermoplastic	\$327.00

Surface Mount

Powder Coat or Galvanized	\$331.00
Thermoplastic	\$382.00

Hi Roller 3H [Parks 5 Bikes] [65" Long]

Inground Mount

Powder Coat or Galvanized	\$309.00
Thermoplastic	\$371.00

Surface Mount

Powder Coat or Galvanized	\$371.00
Thermoplastic	\$433.00

Hi Roller 4H [Parks 6 Bikes] [89" Long]

Inground Mount

Powder Coat or Galvanized	\$394.00
Thermoplastic	\$467.00

Surface Mount

Powder Coat or Galvanized	\$473.00
Thermoplastic	\$545.00

Hi Roller 5H [Parks 7 Bikes] [113" Long]

Inground Mount

Powder Coat or Galvanized	\$564.00
Thermoplastic	\$650.00

Surface Mount

Powder Coat or Galvanized	\$579.00
Thermoplastic	\$641.00

Please contact Dero for stainless steel pricing.
Thermoplastic finish includes galvanized base finish.



DERO
A PLAYCORE Company

2017 MAPC Price List

Hoop Rack

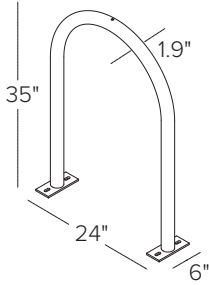

Please contact Dero for stainless steel pricing.
 Thermoplastic and black rubber dip finishes include galvanized base finish.
 All rails are galvanized

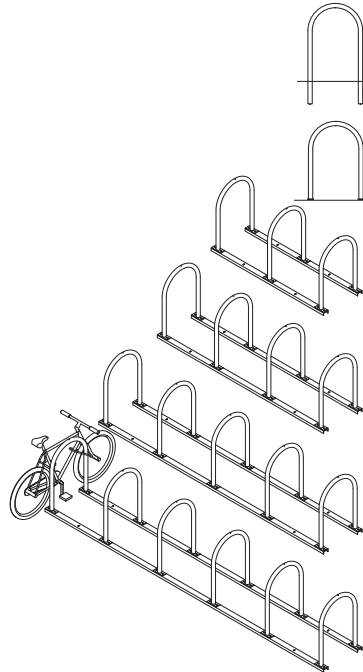

Inground Mount [Parks 2 Bikes]	
Powder Coat or Galvanized.....	\$82.00
Thermoplastic or Black Rubber Dip.....	\$116.00

Surface Mount [Parks 2 Bikes]	
Powder Coat or Galvanized.....	\$84.00
Thermoplastic or Black Rubber Dip.....	\$118.00

3 Hoop Rail Mount [Parks 6 Bikes] [76" Long]	
Powder Coat or Galvanized.....	\$370.00
Thermoplastic or Black Rubber Dip.....	\$472.00

4 Hoop Rail Mount [Parks 8 Bikes] [111" Long]	
Powder Coat or Galvanized.....	\$505.00
Thermoplastic or Black Rubber Dip.....	\$641.00

5 Hoop Rail Mount [Parks 10 Bikes] [146" Long]	
Powder Coat or Galvanized.....	\$659.00
Thermoplastic or Black Rubber Dip.....	\$829.00

6 Hoop Rail Mount [Parks 12 Bikes] [181" Long]	
Powder Coat or Galvanized.....	\$828.00
Thermoplastic or Black Rubber Dip.....	\$1,032.00

Hoop Rack Heavy Duty

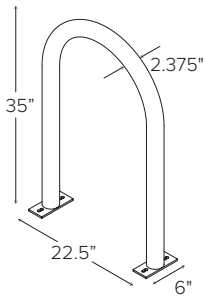

Please contact Dero for stainless steel pricing.
 Thermoplastic and black rubber dip finishes include galvanized base finish.
 All rails are galvanized

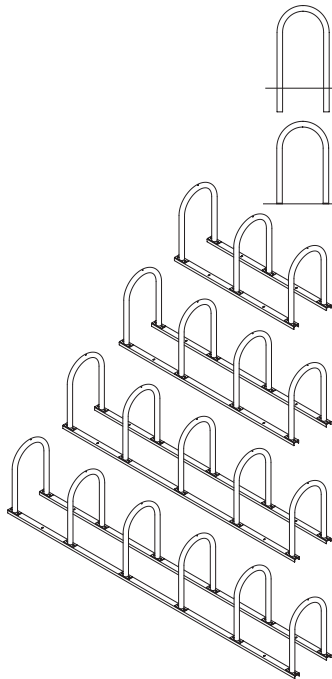

Inground Mount [Parks 2 Bikes]	
Powder Coat or Galvanized.....	\$107.00
Thermoplastic or Black Rubber Dip.....	\$144.00

Surface Mount [Parks 2 Bikes]	
Powder Coat or Galvanized.....	\$113.00
Thermoplastic or Black Rubber Dip.....	\$150.00

3 Hoop Rail Mount [Parks 6 Bikes] [76" Long]	
Powder Coat or Galvanized.....	\$456.00
Thermoplastic or Black Rubber Dip.....	\$569.00

4 Hoop Rail Mount [Parks 8 Bikes] [111" Long]	
Powder Coat or Galvanized.....	\$621.00
Thermoplastic or Black Rubber Dip.....	\$770.00

5 Hoop Rail Mount [Parks 10 Bikes] [146" Long]	
Powder Coat or Galvanized.....	\$803.00
Thermoplastic or Black Rubber Dip.....	\$990.00

6 Hoop Rail Mount [Parks 12 Bikes] [181" Long]	
Powder Coat or Galvanized.....	\$1,001.00
Thermoplastic or Black Rubber Dip.....	\$1,226.00

2017 MAPC Price List

Swerve Rack

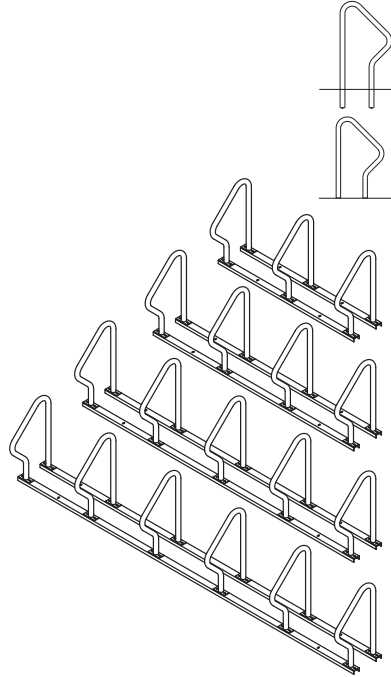
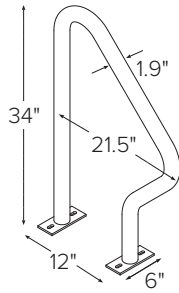

Inground Mount [Parks 2 Bikes]

Powder Coat or Galvanized.....	\$91.00
Thermoplastic or Black Rubber Dip.....	\$128.00

Surface Mount [Parks 2 Bikes]

Powder Coat or Galvanized.....	\$95.00
Thermoplastic or Black Rubber Dip.....	\$131.00

3 Swerve Rail Mount [Parks 6 Bikes] [76" Long]

Powder Coat or Galvanized.....	\$403.00
Thermoplastic or Black Rubber Dip.....	\$510.00

4 Swerve Rail Mount [Parks 8 Bikes] [111" Long]

Powder Coat or Galvanized.....	\$549.00
Thermoplastic or Black Rubber Dip.....	\$692.00

5 Swerve Rail Mount [Parks 10 Bikes] [146" Long]

Powder Coat or Galvanized.....	\$714.00
Thermoplastic or Black Rubber Dip.....	\$893.00

6 Swerve Rail Mount [Parks 12 Bikes] [181" Long]

Powder Coat or Galvanized.....	\$894.00
Thermoplastic or Black Rubber Dip.....	\$1,108.00

Please contact Dero for stainless steel pricing.

Thermoplastic and black rubber dip finishes includes galvanized base finish.

All rails are galvanized



DERO
A PLAYCORE Company

Bike Corrals

Cycle Stall Basic

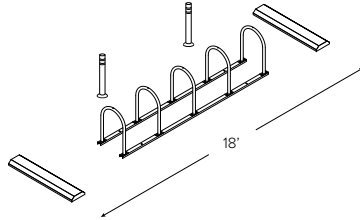

Single Space

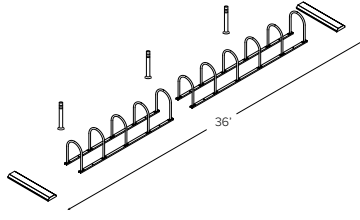

Double Space

Single Space Kit [Parks 10 Bikes]

Powder Coat or Galvanized.....	\$1,125.00
Thermoplastic.....	\$1,308.00

Double Space Kit [Parks 22 Bikes]

Powder Coat or Galvanized.....	\$2,015.00
Thermoplastic.....	\$2,420.00

Please contact Dero for stainless steel pricing.
Thermoplastic finish includes galvanized base finish.



Bike Repair

Air Kit 2

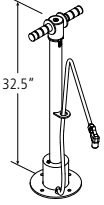

Patent Pending

- Includes air pump/No gauge
- Air pump compatible with presta & schrader valves
- One year warranty on air pump

Surface Mount

Powder Coat or Galvanized.....	\$333.00
Thermoplastic.....	\$359.00

Please contact Dero for stainless steel pricing.
Thermoplastic finish includes galvanized base finish.

Air Kit 3

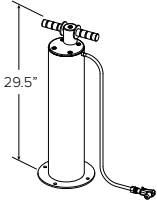

Patent Pending

- Includes air pump with gauge
- Air pump compatible with presta & schrader valves
- One year warranty on air pump

Surface Mount

Powder Coat or Galvanized.....	\$488.00
Thermoplastic.....	\$513.00

Please contact Dero for stainless steel pricing.
Thermoplastic finish includes galvanized base finish.

Fixit Patent D680,914 S

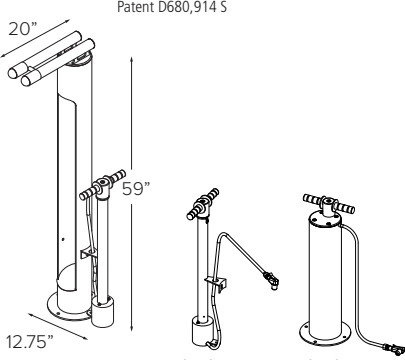

Tools not pictured

Tools Included:

- Air Pump
- Wrench 8mm / 10mm
- Wrench 9mm / 11mm
- Headset wrench 15mm / 32mm
- Phillips screwdriver
- Allen wrench set 2 / 2.5 / 3 / 4 / 5 / 6 / 8 mm
- Flathead screwdriver
- Tire levers (2)

Inground or Surface Mount - No Pump

Powder Coat or Galvanized.....	\$587.00
Thermoplastic.....	\$632.00

Inground or Surface Mount - With Air Kit 2

Powder Coat or Galvanized.....	\$921.00
Thermoplastic.....	\$991.00

Inground or Surface Mount - With Air Kit 3

Powder Coat or Galvanized.....	\$1,075.00
Thermoplastic.....	\$1,146.00

Please contact Dero for stainless steel pricing.
Thermoplastic finish includes galvanized base finish.

Tool Kit



pat. D717,214

Surface Mount

Powder coat or galvanized.....	\$330.00
Thermoplastic.....	\$366.00

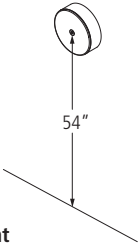

Wall Mount

Powder coat or galvanized.....	\$330.00
Thermoplastic.....	\$366.00

Tools Included:

- Wrench 8mm / 10mm
- Wrench 9mm / 11mm
- Headset wrench 15mm / 32mm
- Phillips screwdriver
- Allen wrench set 2 / 2.5 / 3 / 4 / 5 / 6 / 8 mm
- Flathead screwdriver
- Tire levers (2)

Bike Shelters

Pocket Shelter

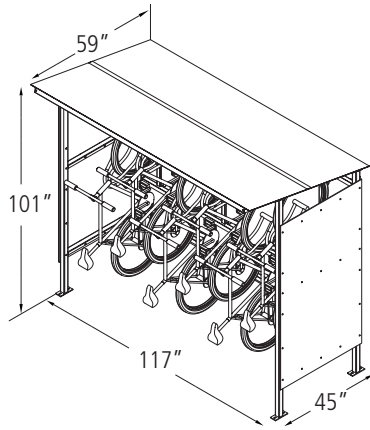

- Vertical parking with Bike Files or Ultra Space Savers
- U-lock compatible
- Various bench combinations available

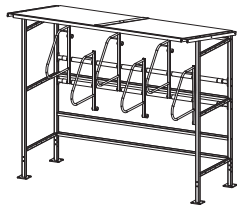
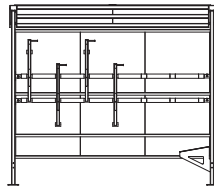

Ultra Space Savers

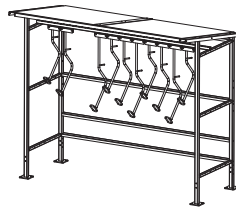

Bike Files

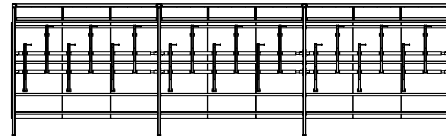

Modular construction - Add sections for more capacity

Surface Mount Only	
Bikes parked per unit (vertically)	6-10
Starter Unit Galvanized, Powder Coated, or Thermoplastic	\$2,524.00
Add-on Unit Galvanized, Powder Coated, or Thermoplastic	\$1,875.00
Bike Files (10 Bikes)	\$1,169.00
Ultra Space Savers (6 Bikes)	\$738.00
Polycarbonate Roof	\$1,367.00
Metal Roof	\$299.00
Side Panels	\$988.00
Rear Panels	\$1,497.00
Bench Short	\$786.00
Bench Long	\$786.00

Bike Depot Shelter

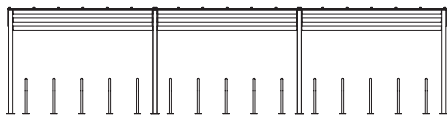
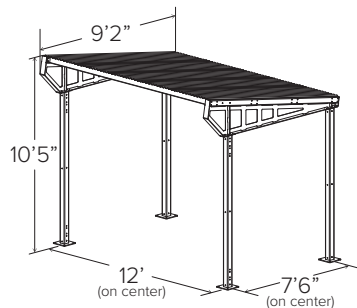

Modular construction - Add sections for more capacity

Surface Mount Only - Corrugated metal roof - Racks NOT included	
Starter Unit Galvanized, Powder Coated, or Thermoplastic	\$3,506.00
Add-on Unit Galvanized, Powder Coated, or Thermoplastic	\$2,212.00
Side Panel - Wire Mesh	\$990.00
Rear Panels - Wire Mesh	\$1,517.00
Front Panels - Wire Mesh	\$2,344.00
Locking Doors	\$3,538.00
Bike Files	\$1,369.00

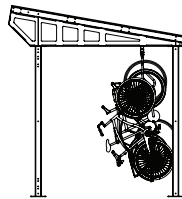

Bike Files
12 Bikes

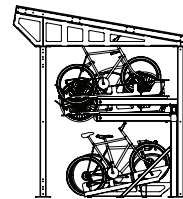

Dero Deckers
12 Bikes

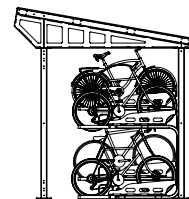

Dero Duplexes
14 Bikes



2017 MAPC Price List

Vizor™ Shelter

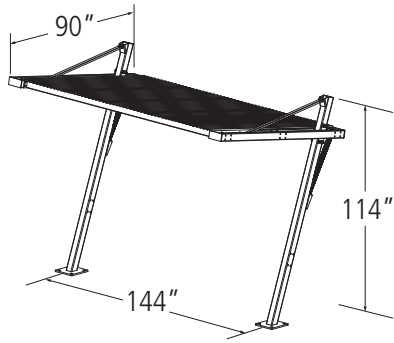

Surface Mount Only - Polycarbonate roof - Racks NOT included	
Starter Unit Galvanized or Powder Coated	\$6,603.00
Add-on Unit Galvanized or Powder Coated	\$3,803.00

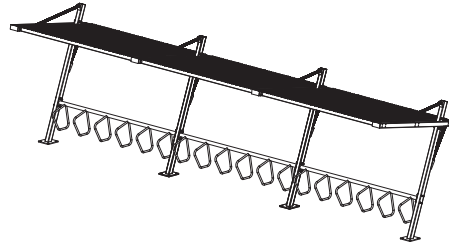

Modular construction - Add sections for more capacity



MAPC Pricelist

Item/Model Quantity Price per Unit/(Discount)

LEANING BIKE RACK



(Photo: LBR-4 – 4 image)

LBR-2 (2 image) 1-2 \$548.00 **(list price)**
 Weight: 70 lbs. 3-9 \$520.60 **(-5%)**
 2 bikes 10-25 \$504.16 **(-8%)**

LBR-3 (3 image) 1-2 \$691.00 **(list price)**
 Weight: 115 lbs. 3-9 \$656.45 **(-5%)**
 3 bikes 10-25 \$642.63 **(-7%)**

LBR-4 (4 image) 1-2 \$826.00 **(list price)**
 Weight: 140 lbs. 3-9 \$784.70 **(-5%)**
 4 bikes 10-25 \$759.92 **(-8%)**

LBR-5 (5 image) 1-2 \$998.00 **(list price)**
 Weight 180 lbs. 3-9 \$948.10 **(-5%)**
 5 bikes 10-25 \$918.16 **(-8%)**

LBR-6 (6 image) 1-2 \$1,165.00 **(list price)**
 Weight 210 lbs. 3-9 \$1,095.10 **(-6%)**
 6 bikes 10-25 \$1,060.15 **(-9%)**

CRUISER



CRUISER 1-3 \$563.00 **(list price)**
 Weight: 75 lbs. 4-15 \$529.22 **(-6%)**
 16-25 \$523.59 **(-7%)**

TANDEM



TANDEM IS NOT YET AVAILABLE THROUGH PURCHASE VIA THE MAPC PROGRAM. IT WILL BE IN THE NEAR FUTURE AFTER MODIFICATIONS TO MEET MAPC STANDARDS.

BOLT ON BIKE RACK

Designed to utilize the posts of existing meter poles. As cities and municipalities across the nation are choosing to upgrade their car parking there isn't much use for these posts, until now. For the same price it costs to remove the unused posts we can turn them into bicycle parking for the future.



BOBR	1 -10	\$153.50	(list price)
Weight: 12 lbs. each	11-49	\$144.30	(-6%)
	50-99	\$121.95	(-21%)
	100-149	\$118.19	(-23%)
	150+	\$115.12	(-25%)

Item/Model Quantity Price per Unit/(Discount)

WELDED BIKE CIRCLE



WBC	1-3	\$196.00	(list price)
Weight: 30 lbs. each	4-9	\$186.20	(-5%)
	10-25	\$182.28	(-7%)

FACE PLANT



FP	1-2	\$628.00	(list price)
Weight: 75 lbs.	3-9	\$596.60	(-5%)
	10-25	\$584.04	(-7%)

300 RACK



300Rack	1-2	\$192.00	(list price)
Weight: 40 lbs.	3-9	\$180.48	(-6%)
	10-25	\$176.64	(-8%)

Item/Model Quantity Price per Unit/(Discount)

MONORAIL



(Photo: MO-6)

MO-4 (4 bike cap.)	1-2	\$419.30	(list price)
2 rings/3ft.	3-9	\$398.33	(-5%)
Weight: 60lbs.	10-25	\$389.95	(-7%)
MO-6 (6 bike cap.)	1-2	\$553.00	(list price)
4 rings/5ft.	3-9	\$525.35	(-5%)
Weight: 80 lbs.	10-25	\$514.29	(-7%)
MO-8 (8 bike cap.)	1-2	\$678.00	(list price)
6 rings/7 ft.	3-9	\$637.32	(-6%)
Weight: 100 lbs.	10-25	\$623.76	(-8%)
MO-10 (10 bike cap.)	1-2	\$859.00	(list price)
8 rings/9ft.	3-9	\$816.05	(-5%)
Weight: 120 lbs.	10-25	\$790.28	(-8%)

VINTAGE BIKE RACK

Same pricing for all models; Logo available and subject to custom logo pricing

VB1/VB2/VB3	1-3	\$349.00	(list price)
	4-9	\$335.00	(-4%)
	10-25	\$328.00	(-6%)



VB1



VB2



VB3

Item/Model Quantity Price per Unit/(Discount)

PARKWELL



PW-2	1-2	\$419.00	(list price)
Weight: 60 lbs.	3-9	\$398.05	(-5%)
	10-25	\$389.67	(-7%)

PW-3	1-2	\$539.00	(list price)
Weight: 75 lbs.	3-9	\$512.05	(-6%)
	10-25	\$495.88	(-8%)

PW-4	1-2	\$759.00	(list price)
Weight: 90lbs.	3-9	\$713.46	(-6%)
	10-25	\$698.28	(-8%)

PW-5	1-2	\$867.00	(list price)
Weight: 100lbs.	3-9	\$823.65	(-5%)
	10-25	\$797.64	(-8%)

PARKWELL – DOUBLE SIDED

Prices include "Bike" emblem on top bar and poly-sleeve.



PWDS-4	1-2	\$659.00	(list price)
(Double-sided)	3-9	\$626.05	(-5%)
Weight: 90 lbs.	10-25	\$606.28	(-8%)

PWDS-6	1-2	\$968.00	(list price)
(Double-sided)	3-9	\$909.92	(-6%)
Weight: 120 lbs.	10-25	\$890.56	(-8%)

PWDS-8	1-2	\$1,197.00	(list price)
(Double-sided)	3-9	\$1,125.18	(-6%)
Weight 160 lbs.	10-25	\$1,101.24	(-8%)

Item/Model Quantity Price per Unit/(Discount)

SWIZZLE STICK BIKE RACK



Swizzle Stick	1-2	\$329.00	(list price)
Weight: 40 lbs.	3-9	\$312.55	(-5%)
	10-25	\$302.68	(-8%)

SEATTLE “RAIL” RACK

Includes poly sleeve.



SRAIL	1-5	\$597.00	(list price)
Weight: 45 lbs.	6-15	\$549.24	(-8%)
	16-25	\$525.36	(-12%)

Item/Model Quantity Price per Unit/(Discount)

HIGH WHEELER



HW-1

HW-1	1-2	\$659.00	(list price)
(spoked wheel)	3-9	\$626.05	(-5%)
Weight: lbs.	10-25	\$606.28	(-8%)

HW-2	1-2	\$559.00	(list price)
(NO spoked wheel)	3-9	\$531.05	(-5%)
Weight: lbs.	10-25	\$514.28	(-8%)



HW-2

THE DAVIS SHELTER



(Davis Shelter 15')

DAVIS-6	6 ft.	\$1,350.00
Weight: 255 lbs.		

DAVIS-9	9 ft.	\$1,550.00
Weight: 310 lbs.		

DAVIS-12	12 ft.	\$1,750.00
Weight: 365 lbs.		

DAVIS-15	15 ft.	\$1,950.00
Weight: 420 lbs.		

DAVIS-18	18 ft.	\$2,450.00
Weight: 545 lbs.		



FINISHINGS

Prices are based on single color powder coating and include sandblasting. Galvanizing, primer or thermoplastic coating is available also for an additional charge.

There is no sales tax in Oregon.

QUANTITY	PRIMER Per Unit	GALVANIZING Per Lb.
<i>2-3 units</i>	<i>Add \$55.00</i>	<i>Min. charge \$250, after 100 lbs. add \$1.35 per lb.</i>
<i>4-10 units</i>	<i>Add \$43.00</i>	<i>Min. charge \$250, after 100 lbs. add \$1.35 per lb.</i>
<i>10+ units</i>	<i>Add \$34.00</i>	<i>Min. charge \$250, after 100 lbs. add \$1.35 per lb.</i>

CUSTOMIZED RACKS

Customized bike racks are available and priced by the following:

- 1- Design time @ \$110.00 per hour.
- 2- Machine time @ \$3.00 per minute (laser cutting and specialty forming).
- 3- Additional shop time @ \$80.00 per hour.
- 4- Additional Materials
 - a- Sch. 40 pipe @ \$1.40 per lb.
 - b- Square tube between the sizes of 1” and 3” @ \$1.85 per lb.
 - c- Steel plate between the thicknesses of 16 gauge and 3/8” thick @ \$1.45 per lb.

A large portfolio of our custom racks can be found here:

http://www.creativemetalworksllc.com/?page_id=344